



# Altus

MODERN FAN COMPANY  
Customer Service  
M-F 8am - 4pm (PST)

(ph) 888.588.3267  
www.modernfan.com

## **Altus Fan**- Installation instructions

Should you have any questions or difficulty installing your new fan, please contact Modern Fan Co. customer service immediately.

**Note:** Power supply must be turned off prior to any contact with electrical wires. It is recommended that a licensed electrician be hired to install your ceiling fan.

**(1)** Remove and identify contents of carton.

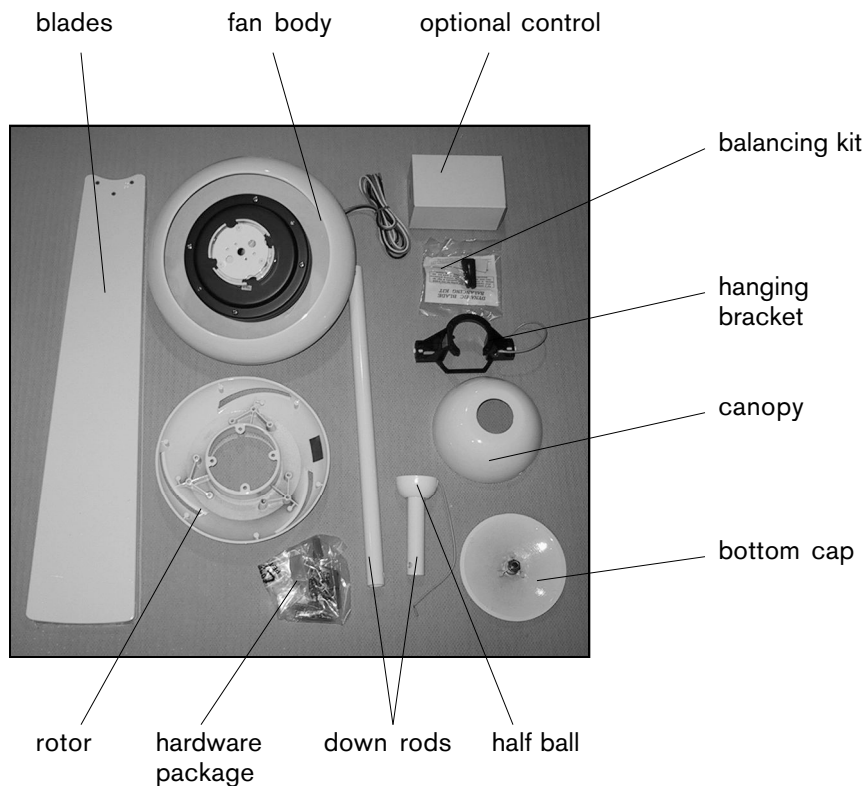

**(2)** Using the existing screws from your junction box, or the machine screws from the hardware package, secure the hanging bracket to the ceiling junction box.



**(3)** Remove the stopper screw and loosen the set screw on the fan collar. Set the stopper screw aside for step **(5)**.

stopper screw  
set screw

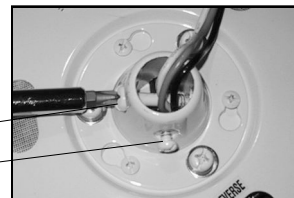

---

**(4)** Remove stopper pin and half ball from small down rod by loosening set screw on half ball. Set all parts aside for steps **(5)** and **(7)**.

stopper pin  
set screw

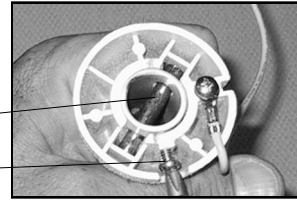

---

**(5)** Run fan wires through selected down rod. Reinstall stopper screw from step **(3)** and firmly tighten set screw on fan collar against down rod.

**Note:** If ceiling height allows, using a longer down rod will increase airflow and efficiency.

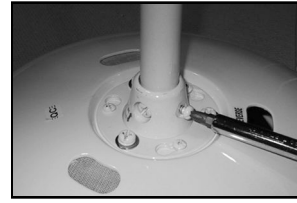

---

**(6)** Slide fan canopy over down rod and carefully rest on top of fan body.



---

**(7)** Reinstall half ball on end of down rod. Be sure that stopper pin is inserted through down rod and seated in half ball. Tighten set screw against down rod.

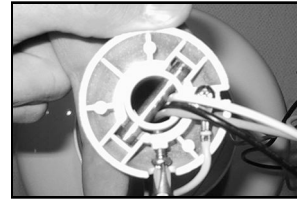

---

**(8)** Lift fan to ceiling and set half ball in the hanging bracket so that the ridge on the edge of the hanging bracket is seated in the slotted channel in the half ball.

With fan safely suspended by bracket, make wire connections with wire nuts included in hardware package as described in the control installation instructions. If using the optional #003 or #004 control, the receiving unit should be placed inside the arms of the hanging bracket and connected now.



---

**(9)** Loosen set screws on the sides of the hanging bracket. Lift canopy to ceiling. With slots on side of canopy aligned with set screws on hanging bracket, tighten set screws to hold canopy in place.

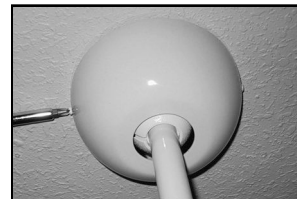

---

**(10)** Carefully insert blades into rotor slots, and using pan head screws from hardware package, secure blades to rotor.

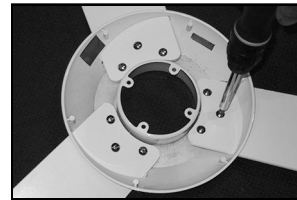

---

**(11)** Remove four rotor screws from motor and set aside for step **(12)**.

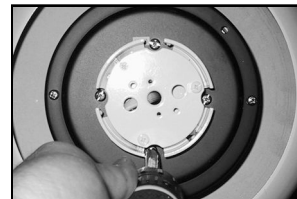

**(12)** Install rotor using the four rotor screws from step **(11)**. Be sure screw tabs on rotor are properly aligned with correct holes on motor.

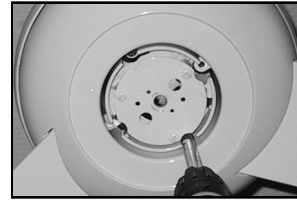

**(13)** Install bottom cap by rotating in the clockwise direction, or if using the optional light, proceed to step **(14)**.

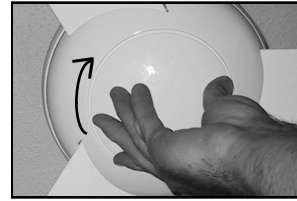

**(14)** To install optional light kit, begin by identifying all parts. Then follow steps **(a)** through **(e)**:

globe  
socket screws  
socket

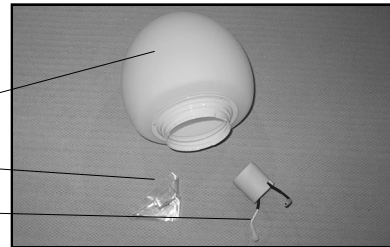

**(a)** Remove the three socket plate screws and set aside for step **(c)**.

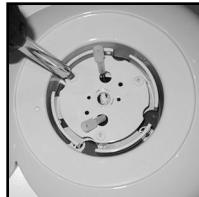

**(b)** Run socket wires through socket plate, connect to wire leads from fan, and screw socket to socket plate with socket screws.

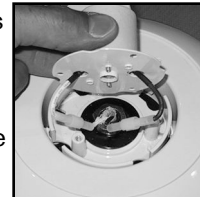

**(c)** Reinstall socket plate with screws from step **(a)**.

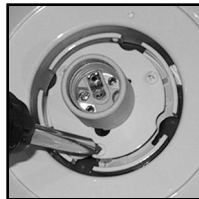

**(d)** Install standard (A-19) lamp (75 watt max.). Lamp not included.

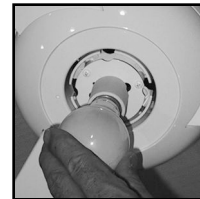

**(e)** Align channels in globe with fittings on fan and rotate clockwise until securely in place.

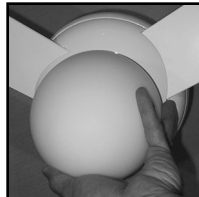

**(15)** Install control as described in the control installation instructions.

**(16)** Your fan is reversible for summer and winter operation. The reverse switch is located on the top of the fan body. The LEFT position is for summer and the RIGHT position is for winter.

reverse switch

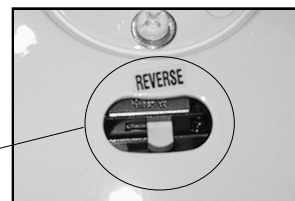

**(17)** The rotor and motor of your fan have been dynamically balanced at the factory. In addition, the blades have been matched to the nearest gram to ensure a well balanced ceiling fan. Furthermore, a blade balancing kit has been included with your fan. Please refer to the instructions packaged with the balancing kit should your fan require additional balancing.

## Modern Fan / Period Arts Fan Controls

Our ceiling fans do not use conventional pull chains (with the exception of the Industry model). When ordering your fan, you should have selected the control that was most appropriate for your fan and electrical requirements. Third party controls are generally compatible but must be FAN SPEED CONTROLS with specific speed settings. Continuous, variable speed controls or rheostats are not compatible with our fans, are likely to cause motor noise and will void your ceiling fan warranty.

---

### Control options are as follows:



#### #001- Fan Speed Control

A basic fan control used to operate a fan only, providing four speeds. Can be used in combination with a separate light switch/dimmer in a double-gang wall box to control a fan with light.



#### #002/002ND- Three Wire Fan Speed & Light Control

Intended for operation of a fan with light. Requires two circuits (three wires). #002 provides four speeds and full range dimming; #002ND (for fluorescent lights) provides three speeds and on/off switching of light.



#### #003- Handheld Remote Control

Designed for independent operation of a fan and light using only one circuit (two wires). Provides three speeds and full range dimming (for halogen or incandescent lamps) or "on/off" switching (for fluorescent lamps) and comes with a wall hanging bracket.



#### #004- Two Wire Fan Speed & Light Control

Designed for independent operation of a fan and light using only one circuit (two wires). Provides three speeds and full range dimming (for halogen or incandescent lamps) or "on/off" switching (for fluorescent lamps) and wires into wall box.



#### #005- Two Wire Wall Control with Remote Handset

A combination control package including our #004 Fan & Light Control and our #003 Remote Control handset. Provides three speeds and full range dimming (for halogen or incandescent lamps) or "on/off" switching (for fluorescent lamps) from wall control and compatible remote handset.



#### #009A/009B- Multi-Fan Speed Controls

A three speed fan control designed to control two fans (#009A) or three to five fans (#009B) on a single circuit. Separate control/switching of lights must be planned for if this control is to be used for fans with lights.

**Installation Instructions:** With power turned off at breaker, make wire connections from the fan to the power supply at the ceiling and from the control to power at wall box as shown in the wiring diagrams below. Your fan may have dedicated neutral wires for the motor (WHITE) and for the light (ORANGE) or may have a common neutral (WHITE only). **Note:** For #009A or #009B, refer to printed instructions included in control box/packaging.

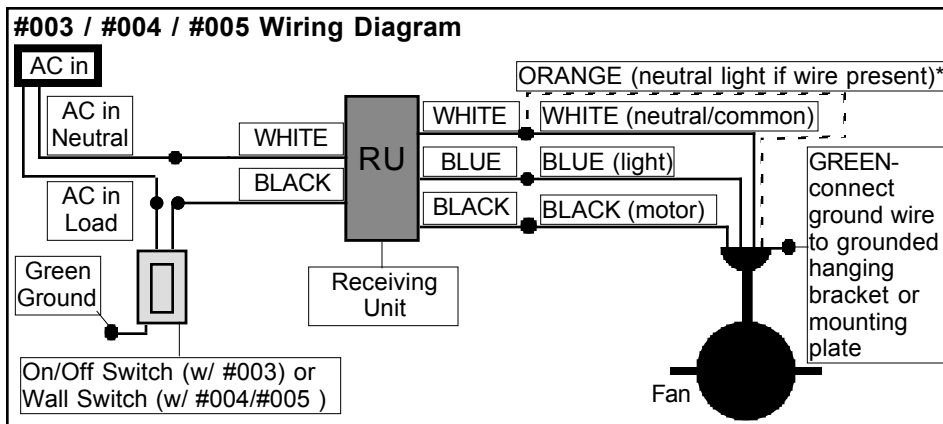
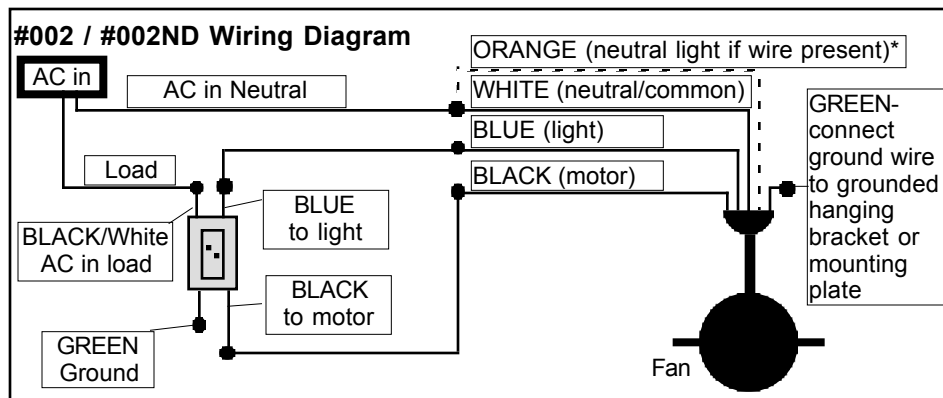
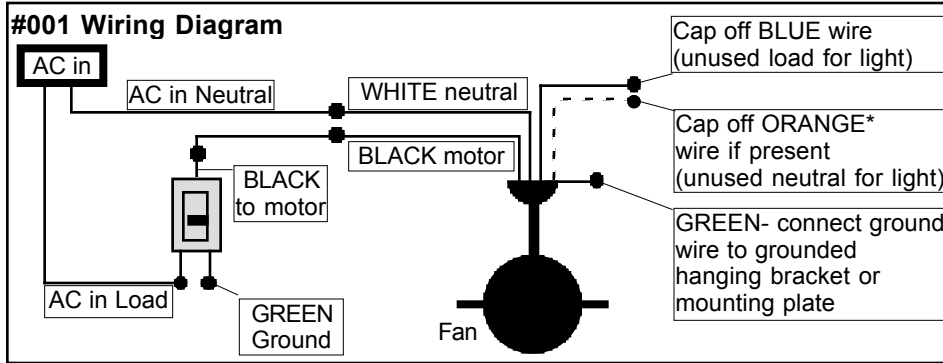

\* Your fan may have dedicated neutral wires for the motor (WHITE) and for the light (ORANGE) or may have a common neutral (WHITE only).

**#003, #004 and #005 Receiving Unit Wiring Instructions:**

With fan suspended from ceiling and with power off at breaker box, make wire connections as shown below. The receiving unit sits in the ball hanging bracket of most models as pictured (a), or in the upper portion of the fan body in Huger fans, Stratos, Eclipse and Pensi models (b) and (c).

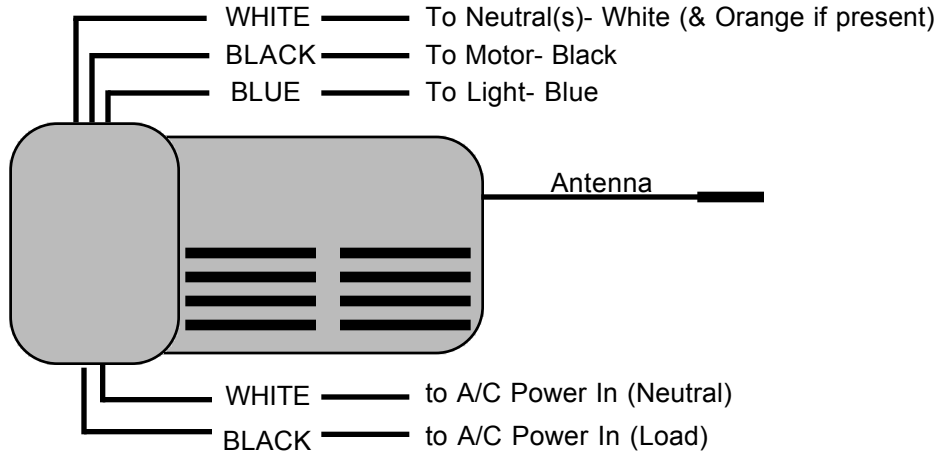

**Receiving Unit Placement:**

While there is ample room for the receiving unit as shown here, the wires can sometimes become difficult to manage in the space available. Trimming excess wire before making connections can ease wire management.

**Tip:** Splicing lighter gauge wire to the power supply and positioning the heavier wires up into the junction box can also ease wire management.

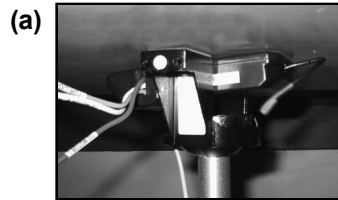
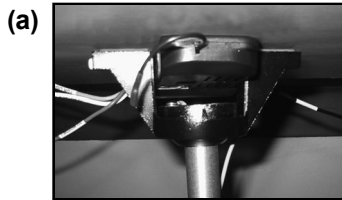

**Reminder:** Any fan that uses a fluorescent lamp may not be dimmed or operated with a dimming control. A non-dimming version of our #002 (designated by the suffix "ND") is available for use with a fluorescent lamp. For #003/#004/#005, see "Dimming Selection Setting" on next page.

### **Instructions for Setting Remote Frequency:**

The #003/#004/#005 controls use a two or three component system. The wall switch and/or handset is preset to the same frequency as the receiving unit. You may want to change these settings if:

- (a) Other RF signals or appliances are interfering with operation of your ceiling fan.
- (b) You are installing more than one fan in close proximity, and you want to control these fans separately.



Locate the dip switches as pictured to right, and carefully select a new combination of "on" and "off" switches. Within 60 seconds of turning the AC power on, press and hold down the "fan off" button for five seconds. The receiver will then lock in the the chosen frequency. Test operation to confirm transmitter and receiver are synced together. If using a handset and wall switch in combination (#005) the dip switches must match.

### **Dimming Selection Setting (for #003/#004/#005):**

Adjacent to the dip switches on the remote handset (for #003/#005) and the wall unit (for #004/#005) as pictured above, there is a *dimming selection switch* which determines whether your control will dim the light or simply turn it on and off. **Note:** any fan that uses a fluorescent lamp may not be dimmed or operated with a dimming control.

The "D" position enables the dimming function while the "ON" position allows for on/off switching only. Do not confuse the "ON" marking for the *dimming selection switch* with the "ON" marking for the four dip switches.

When dimming is enabled, the light button on the face of the control can be pressed and held down to progress through the dimming cycle to the desired light level.

---

### **Other Notes and Tips:**

- 1) Due to the electronic nature of our #003/#004/#005 controls, it is recommended that power be turned off at the wall location during electrical storms or during long periods of vacancy. This will limit the possibility of damage to the electronic components in the receiving unit.
- 2) All controls are designed for one fan only (except #009A/009B as noted). To control multiple fans with a single remote handset (#003) or wall switch (#004), please consult your dealer or The Modern Fan Co. regarding the purchase of additional receiving units.
- 3) #001, #002 and #009 controls are NOT compatible with the #003 remote control.
- 4) Should you have any questions or difficulty installing your new fan, please contact Modern Fan Co. customer service immediately:

**MODERN FAN CO. / PERIOD ARTS FAN CO.**  
Customer Service (ph) 888-588-3267 or 541-482-8545  
M-F 8am - 4pm (PST) www.modernfan.com